

FLOW

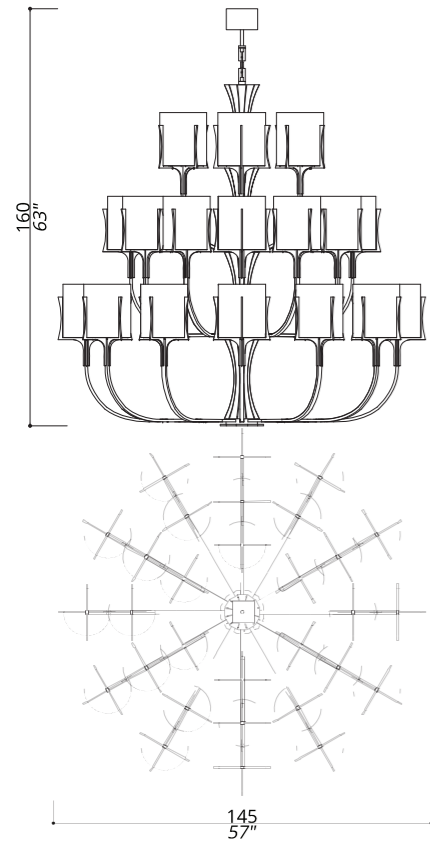

1111-GW-24 CHANDELIER THREE LAYERED CHANDELIER; EBONY WOOD STICKS CENTRAL DESIGN. 50 CENTIMETRES OF CHAIN INCLUDED.

STRUCTURE AND CONNECTION BOX IN F_15 (SATIN GOLD FINISH); CENTRAL STRUCTURE IN EBONY WOOD IN SATIN FINISH. SHADES IN TS_24 (GOLD TREVIRA WAVE).

1111-NN-22 STRUCTURE AND CONNECTION BOX IN F_31 & F_33 (POLISHED & BRUSHED NICKEL FINISH); CENTRAL STRUCTURE IN EBONY WOOD IN SATIN FINISH. SHADES IN TS_22 (IVORY TREVIRA WAVE).

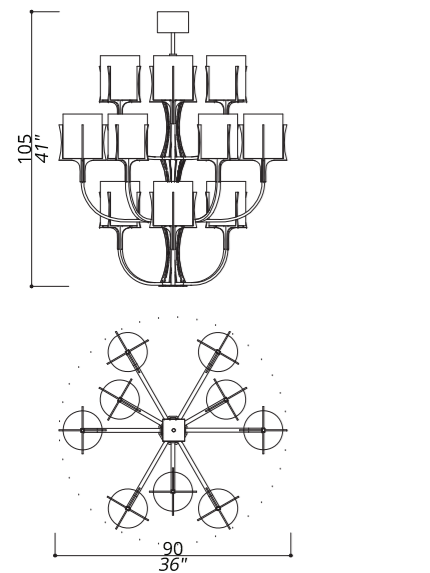

1112-GW-24 MODULAR CHANDELIER THREE LAYERED MODULAR CHANDELIER; EBONY WOOD STICKS CENTRAL DESIGN. 50 CENTIMETRES OF CHAIN INCLUDED.

STRUCTURE AND CONNECTION BOX IN F_15 (SATIN GOLD FINISH); CENTRAL STRUCTURE IN EBONY WOOD IN SATIN FINISH. SHADES IN TS_24 (GOLD TREVIRA WAVE).

1112-NW-S STRUCTURE AND CONNECTION BOX IN F_35 (ANTIQUED NICKEL FINISH); CENTRAL STRUCTURE IN EBONY WOOD IN SATIN FINISH. SATIN GLASS SHADES.

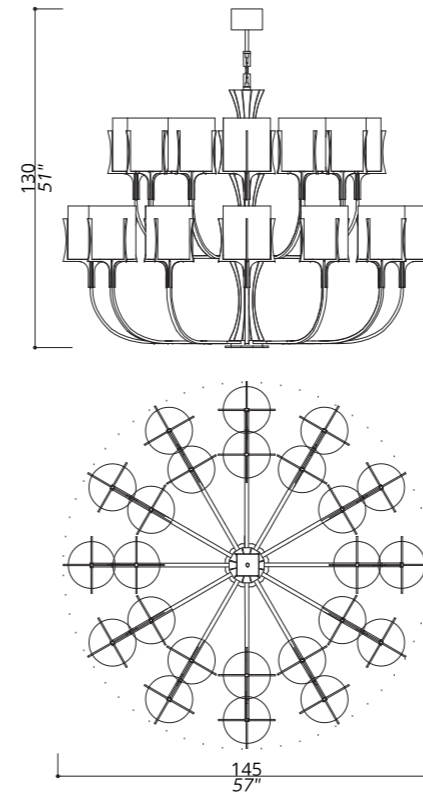

1115-GW-24 CHANDELIER TWO LAYERED CHANDELIER; EBONY WOOD STICKS CENTRAL DESIGN. 50 CENTIMETRES OF CHAIN INCLUDED.

STRUCTURE AND CONNECTION BOX IN F_15 (SATIN GOLD FINISH); CENTRAL STRUCTURE IN EBONY WOOD IN SATIN FINISH. SHADES IN TS_24 (GOLD TREVIRA WAVE).

24 LIGHTS
TYPE E14

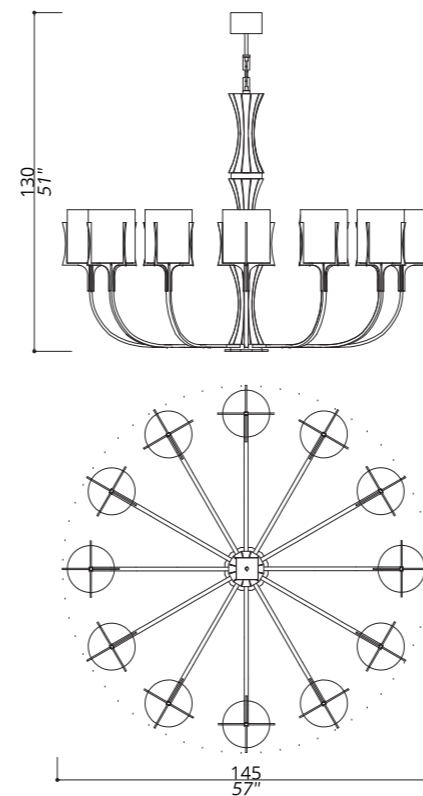

1116-GW-24 CHANDELIER EBONY WOOD STICKS CENTRAL DESIGN. 50 CENTIMETRES OF CHAIN INCLUDED.

STRUCTURE AND CONNECTION BOX IN F_15 (SATIN GOLD FINISH); CENTRAL STRUCTURE IN EBONY WOOD IN SATIN FINISH. SHADES IN TS_24 (GOLD TREVIRA WAVE).

12 LIGHTS
TYPE E14

1116-NW-S STRUCTURE AND CONNECTION BOX IN F_35 (ANTIQUED NICKEL FINISH); CENTRAL STRUCTURE IN EBONY WOOD IN SATIN FINISH. SATIN GLASS SHADES.

FLOW

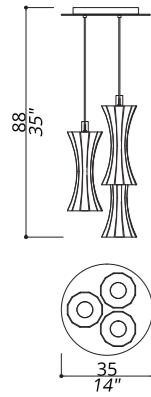

1150-GW TRIPLE PENDANT COMPOSITION OF 3 FIXTURES. 100 CENTIMETRES OF STEEL WIRE INCLUDED. 3 LIGHTS GU10 LED INCLUDED
CONNECTION BOX IN F_15 (SATIN GOLD FINISH); CENTRAL STRUCTURE IN EBONY WOOD IN SATIN FINISH.

1150-NW CONNECTION BOX IN F_35 (ANTIQUED NICKEL FINISH); CENTRAL STRUCTURE IN EBONY WOOD IN SATIN FINISH.

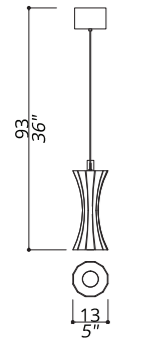

1151-GW SINGLE PENDANT SINGLE FIXTURE. 100 CENTIMETRES OF STEEL WIRE INCLUDED. 1 LIGHT GU10 LED INCLUDED
CONNECTION BOX IN F_15 (SATIN GOLD FINISH); CENTRAL STRUCTURE IN EBONY WOOD IN SATIN FINISH.

1151-NW CONNECTION BOX IN F_35 (ANTIQUED NICKEL FINISH); CENTRAL STRUCTURE IN EBONY WOOD IN SATIN FINISH.

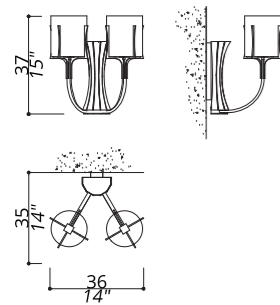

1122-GW-24 WALL LAMP WALL FIXTURE IN F_15 (SATIN GOLD FINISH); CENTRAL STRUCTURE IN EBONY WOOD IN SATIN FINISH. 2 LIGHTS TYPE E14
SHADES IN TS_24 (GOLD TREVIRA WAVE).

1122-NW-22 WALL FIXTURE IN F_35 (ANTIQUED NICKEL FINISH); CENTRAL STRUCTURE IN EBONY WOOD IN SATIN FINISH. SHADES IN TS_22 (IVORY TREVIRA WAVE).

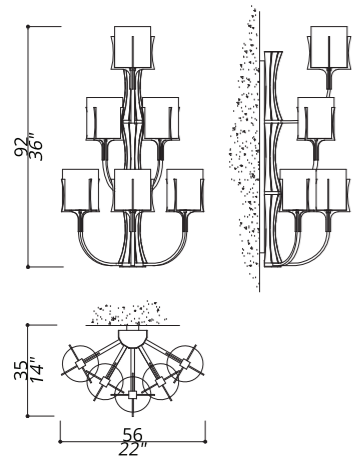

1125-GW-24 WALL LAMP WALL FIXTURE IN F_15 (SATIN GOLD FINISH); CENTRAL STRUCTURE IN EBONY WOOD IN SATIN FINISH. 6 LIGHTS TYPE E14
SHADES IN TS_24 (GOLD TREVIRA WAVE).

1125-NW-22 WALL FIXTURE IN F_35 (ANTIQUED NICKEL FINISH); CENTRAL STRUCTURE IN EBONY WOOD IN SATIN FINISH. SHADES IN TS_22 (IVORY TREVIRA WAVE).

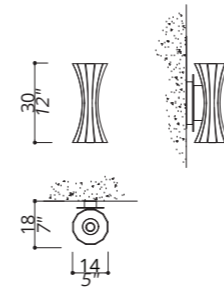

1129-GW WALL LAMP WALL FIXTURE IN F_15 (SATIN GOLD FINISH); CENTRAL STRUCTURE IN EBONY WOOD IN SATIN FINISH. 2 LIGHTS GU10 LED INCLUDED

1129-NW WALL FIXTURE IN F_33 (SATIN NICKEL FINISH); CENTRAL STRUCTURE IN EBONY WOOD IN SATIN FINISH.

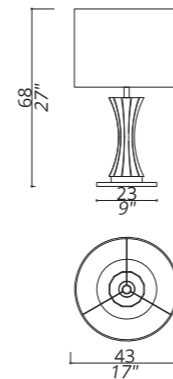

1132-GW-24 TABLE LAMP STRUCTURE AND BASE IN F_15 (SATIN GOLD FINISH); CENTRAL STRUCTURE IN EBONY WOOD IN SATIN FINISH. METAL BASE. SHADE IN TS_24 (GOLD TREVIRA WAVE). 1 LIGHT TYPE E27

1132-NW-22 STRUCTURE AND BASE IN F_35 (ANTIQUED NICKEL FINISH); CENTRAL STRUCTURE IN EBONY WOOD IN SATIN FINISH. METAL BASE. SHADE IN TS_22 (IVORY TREVIRA WAVE).

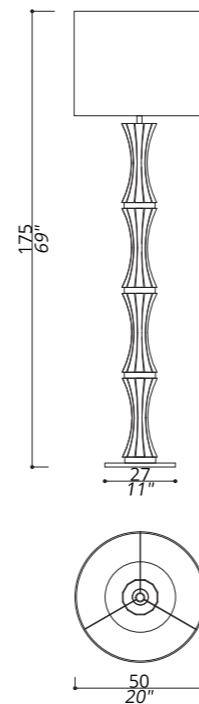

1142-GW-24 FLOOR LAMP STRUCTURE AND BASE IN F_15 (SATIN GOLD FINISH); CENTRAL STRUCTURE IN EBONY WOOD IN SATIN FINISH. METAL BASE. SHADE IN TS_24 (GOLD TREVIRA WAVE). 1 LIGHT TYPE E27

1142-NW-22 STRUCTURE AND BASE IN F_35 (ANTIQUED NICKEL FINISH); CENTRAL STRUCTURE IN EBONY WOOD IN SATIN FINISH. METAL BASE. SHADE IN TS_22 (IVORY TREVIRA WAVE).